

Raccords électriques non-métalliques ENT

Liste de prix au Canada
Liste de prix : E-80-03-ENT-PLV21-F
En vigueur : 9 février 2024
Remplace : 4 juillet 2022
Nos prix n'incluent pas les taxes

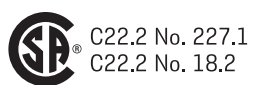

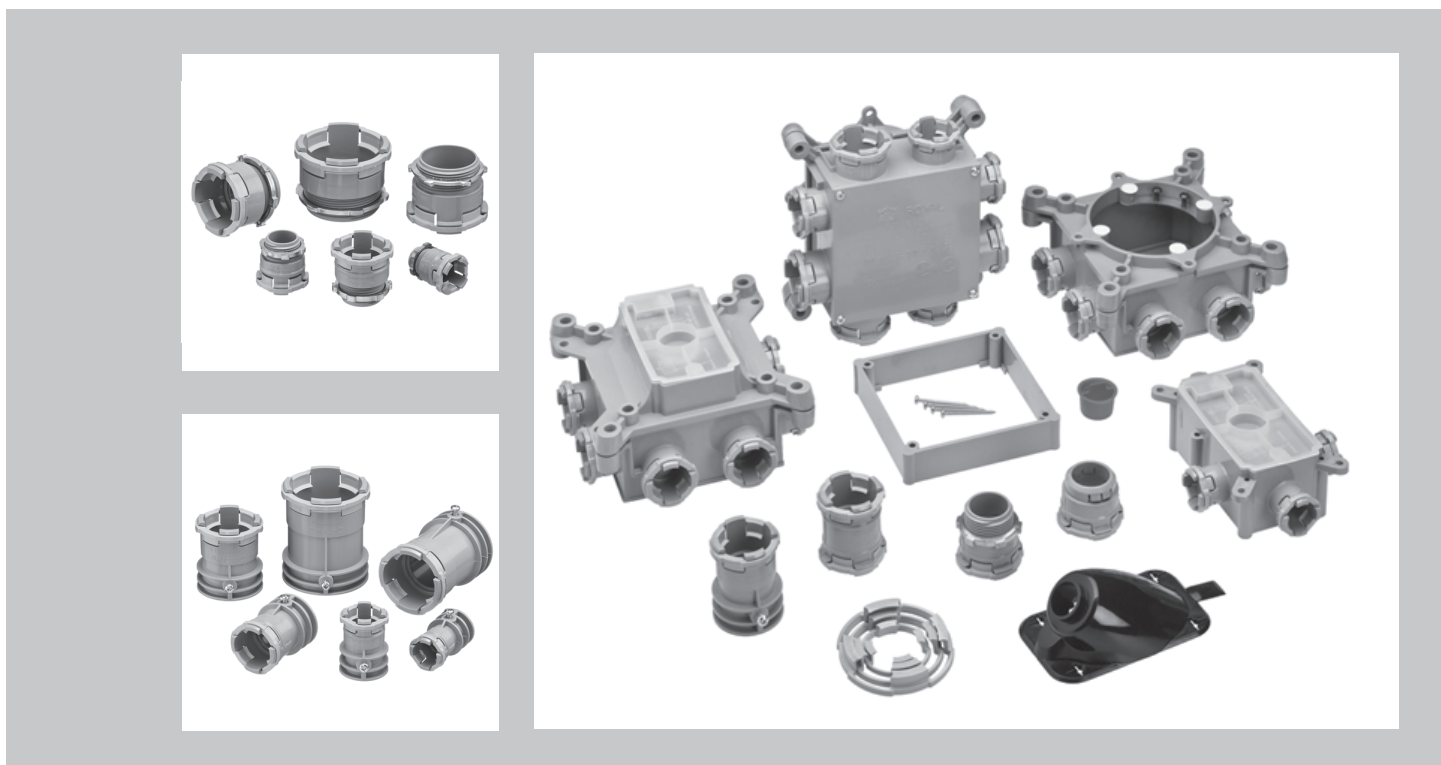



C22.2 No. 227.1
C22.2 No. 18.2







UL 1653
UL 514C

Raccords électriques non-métalliques ENT

Description (Raccords)	No. du Produit	No. de UPC	Dim mm (po)	Quantité Carton	Prix par 100
Manchons en PVC (RKC)					
	RKC10	49530	12 (1/2)	150	\$792.00
	RKC15	49540	19 (3/4)	100	\$1,286.00
	RKC20	49550	25 (1)	50	\$2,063.00
	RKC25	49554	32 (1 1/4)	50	\$2,289.00
	RKC30	49556	38 (1 1/2)	40	\$2,535.00
	RKC35	49558	50 (2)	25	\$2,809.00
Connecteurs rapides en PVC (RKTA) - avec écrou de blocage					
	RKTA10	49750	12 (1/2)	150	\$578.00
	RKTA15	49760	19 (3/4)	100	\$975.00
	RKTA20	49770	25 (1)	50	\$1,697.00
	RKTA25	49774	32 (1 1/4)	50	\$2,289.00
	RKTA30	49776	38 (1 1/2)	50	\$2,535.00
	RKTA35	49778	50 (2)	25	\$2,809.00
Raccord à branchement rapide en PVC (RKTS)					
	RKTS10	49700	12 (1/2)	150	\$577.00
	RKTS15	49710	19 (3/4)	100	\$975.00
	RKTS20	49715	25 (1)	50	\$1,697.00
Adaptateur rapide en PVC (RKTC)					
	RKTC10	49580	12 (1/2)	125	\$824.00
	RKTC15	49590	19 (3/4)	100	\$1,357.00
	RKTC20	49600	25 (1)	50	\$2,174.00
	RKTC25	55000	32 (1 1/4)	50	\$2,410.00
	RKTC30	55002	38 (1 1/2)	40	\$2,668.00
	RKTC35	55004	50 (2)	15	\$2,959.00
Anneaux à pinces ENT (RKR)					
	RKR10	55054	12 (1/2)	10 x 20/200	\$13.00
	RKR15	55056	19 (3/4)	10 x 20/200	\$17.00
	RKR20	55058	25 (1)	10 x 20/200	\$23.00
	RKR25	55060	32 (1 1/4)	10 x 10/100	\$17.00
	RKR30	55062	38 (1 1/2)	10 x 10/100	\$19.00
	RKR35	55064	50 (2)	10 x 5/50	\$19.00

Raccords électriques non-métalliques ENT

Description (Raccords)	No. du Produit	No. de UPC	Dim mm (po)	Quantité Carton	Prix par 100
Boîte de parquet					
	RECM10	49610	12 (1/2)	150	\$736.00
	RECM15	49620	19 (3/4)	150	\$736.00
	RECM20	49630	25 (1)	200	\$884.00
	RECM25	49640	32 (1 1/4)	200	\$1,508.00
Pince stubby à 45°					
	RKASTB10	55016	12 (1/2)	50	\$923.00
	RKASTB15	55018	19 (3/4)	50	\$923.00
	RKASTB20	55020	25 (1)	50	\$1,089.00
	RKASTB25	55022	32 (1 1/4)	50	\$1,879.00
	RKASTB30	55024	38 (1 1/2)	50	\$2,063.00
	RKASTB35	55026	50 (2)	50	\$2,265.00
Bouchons coniques					
	RTP10	49780	12 (1/2)	250	\$207.00
	RTP15	49790	19 (3/4)	100	\$214.00
	RTP20	49800	25 (1)	100	\$312.00
Écrou de blocage à haut rendement					
	RLN10	49670	12 (1/2)	200	\$66.00
	RLN15	49680	19 (3/4)	200	\$109.00
	RLN20	49690	25 (1)	200	\$190.00
	RLN25	49672	32 (1 1/4)	200	\$232.00
	RLN30	49674	38 (1 1/2)	200	\$264.00
	RLN35	49676	50 (2)	200	\$301.00
Anneau de prolongement de 1" pour de dalle - avec longue vis (A utiliser uniquement avec les boîtiers à encastrer RSMB et RSMB-H standard. Référence pages 4 et 5)					
	R SMBEXTENSION	49996	-	10	\$3,559.00

Raccords électriques non-métalliques ENT

Boîte Logique Royal - Boîte de dalle avec connecteurs moulés - Boîte de grande capacité (51.0 po3)

Description (Raccords)	No. du Produit	No. de UPC	Dim mm (po)	Quantité Carton	Prix par 100
------------------------	----------------	------------	-------------	-----------------	--------------

Boîte murale peu profonde en béton à commande unique

	RSVSB-H-10	55036	12 (1/2)	70	\$3,875.00
	RSVSB-H-15	55038	19 (3/4)	70	\$3,875.00
	RSVSB-H-20	55040	25 (1)	70	\$3,875.00

Boîte murale profonde en béton à commande unique

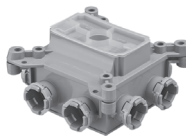
	RSVDB-H-10	55029	8 x 1/2	25	\$11,487.00
	RSVDB-H-15	55034	8 x 3/4	25	\$11,487.00
	RSVDB-H-10-15	55028	4 x 1/2 - 4 x 3/4	25	\$11,487.00
	RSVDB-H-15-20	55030	4 x 3/4 - 4 x 1	25	\$11,487.00
	RSVDB-H-10-20	55032	4 x 1/2 - 4 x 1	25	\$11,487.00
	RSVDB-H-10-15-20	55031	4 x 1/2 - 2 x 3/4 - 2 x 1	25	\$11,487.00

Boîte carrée pour dalle de béton

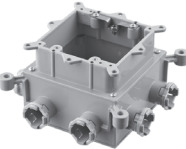
	RSSB-H-10	55070	8 x 1/2	20	\$11,487.00
	RSSB-H-15	55072	8 x 3/4	20	\$11,487.00
	RSSB-H-10-15	55074	4 x 1/2 - 4 x 3/4	20	\$11,487.00
	RSSB-H-15-20	55076	4 x 3/4 - 4 x 1	20	\$11,487.00
	RSSB-H-10-20	55078	4 x 1/2 - 4 x 1	20	\$11,487.00
	RSSB-H-10-15-20	55080	4 x 1/2 - 2 x 3/4 - 2 x 1	20	\$11,487.00

Module isolant de boîte de dalle - avec le couvercle rouge

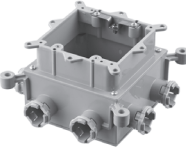
	RSMB-10-IMB	49999	8 x 1/2	20	\$12,707.00
	RSMB-15-IMB	49997	8 x 3/4	20	\$12,707.00
	RSMB-10-15-IMB	49998	4 x 1/2 - 4 x 3/4	20	\$12,707.00
	RSMB-15-20-IMB	55001	4 x 3/4 - 4 x 1	20	\$12,707.00
	RSMB-10-20-IMB	55003	4 x 1/2 - 4 x 1	20	\$12,707.00
	RSMB-10-15-20-IMB	55005	4 x 1/2 - 2 x 3/4 - 2 x 1	20	\$12,707.00

Boîtiers peu profonds

	RSMBS-H-10	55006	8 x 1/2	25	\$9,012.00
	RSMBS-H-15	55012	8 x 3/4	25	\$9,012.00
	RSMBS-H-10-15	55010	4 x 1/2 - 4 x 3/4	25	\$9,012.00
	RSMBS-H-15-20	55014	4 x 3/4 - 4 x 1	25	\$9,012.00
	RSMBS-H-10-20	55008	4 x 1/2 - 4 x 1	25	\$9,012.00
	RSMBS-H-10-15-20	55015	4 x 1/2 - 2 x 3/4 - 2 x 1	25	\$9,012.00

Plaque de séparation (S'adapte seulement sur les boîtes carrés de dalles)

Prix par sac (Net)

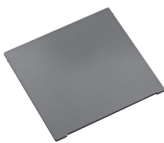
	RSSBH-DC	55065	-	10 par sac	\$19.00

Raccords électriques non-métalliques ENT

Boîte Logique Royal - Boîte de dalle avec connecteurs moules - Boîte de grande capacité (51.0 po3)

Description (Raccords)	No. du Produit	No. de UPC	Couverture (Couleur)	Quantité Carton	Prix aux 100 Unités
------------------------	----------------	------------	----------------------	-----------------	---------------------

Boîte - (8 x 1/2)

	RSMB-H-10	49720	Grey	25	\$9,012.00
	RSMB-H-10G	49721	Green	25	\$10,203.00
	RSMB-H-10W	49722	White	25	\$10,203.00
	RSMB-H-10B	49723	Blue	25	\$10,203.00
	RSMB-H-10Y	49724	Yellow	25	\$10,203.00
	RSMB-H-10R	49725	Red	25	\$10,203.00

Boîte - (8 x 3/4)

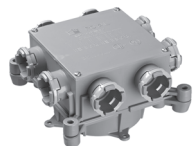
	RSMB-H-15	49801	Grey	25	\$9,012.00
	RSMB-H-15G	49802	Green	25	\$10,203.00
	RSMB-H-15W	49803	White	25	\$10,203.00
	RSMB-H-15B	49804	Blue	25	\$10,203.00
	RSMB-H-15Y	49805	Yellow	25	\$10,203.00
	RSMB-H-15R	49806	Red	25	\$10,203.00

Boîte - (4 x 1/2 - 4 x 3/4)

	RSMB-H-10-15	49730	Grey	25	\$9,012.00
	RSMB-H-10-15G	49731	Green	25	\$10,203.00
	RSMB-H-10-15W	49732	White	25	\$10,203.00
	RSMB-H-10-15B	49733	Blue	25	\$10,203.00
	RSMB-H-10-15Y	49734	Yellow	25	\$10,203.00
	RSMB-H-10-15R	49735	Red	25	\$10,203.00

Boîte - (4 x 3/4 - 4 x 1)

	RSMB-H-15-20	49836	Grey	25	\$9,012.00
	RSMB-H-15-20G	49837	Green	25	\$10,203.00
	RSMB-H-15-20W	49838	White	25	\$10,203.00
	RSMB-H-15-20B	49839	Blue	25	\$10,203.00
	RSMB-H-15-20Y	49846	Yellow	25	\$10,203.00
	RSMB-H-15-20R	49847	Red	25	\$10,203.00

Boîte - (4 x 1/2 - 4 x 1)

	RSMB-H-10-20	49742	Grey	25	\$9,012.00
	RSMB-H-10-20G	49841	Green	25	\$10,971.00
	RSMB-H-10-20W	49842	White	25	\$10,971.00
	RSMB-H-10-20B	49843	Blue	25	\$10,971.00
	RSMB-H-10-20Y	49844	Yellow	25	\$10,971.00
	RSMB-H-10-20R	49845	Red	25	\$10,971.00

Boîte - (4 x 1/2 - 2 x 3/4 - 2 x 1)

	RSMB-H-10-15-20	49740	Grey	25	\$9,012.00
	RSMB-H-10-15-20G	49831	Green	25	\$10,971.00
	RSMB-H-10-15-20W	49832	White	25	\$10,971.00
	RSMB-H-10-15-20B	49833	Blue	25	\$10,971.00
	RSMB-H-10-15-20Y	49834	Yellow	25	\$10,971.00
	RSMB-H-10-15-20R	49835	Red	25	\$10,971.00

Boîte logique royal légende de couleurs

	Gris :	Generique	Bleu :	Hydro - 120 Volt
	Vert :	Sécurité, Câble, Téléphone	Jaune :	Lumière d'Urgence et Enseignes Sortie
	Blanc :	Hydro - 600 Volt	Rouge :	Alarm de Feu

Raccords électriques non-métalliques ENT

Boîte Logique Royal - Anneau de prolongement de 1" pour de dalle - Boîte de grande capacité (51.0 po3)

Description (Raccords)	No. du Produit	No. de UPC	Couverture (Couleur)	Quantité Carton	Prix aux 100 Unités
------------------------	----------------	------------	----------------------	-----------------	---------------------

Boîte - (8 x 1/2)

	RSMB-10	49852	Grey	25	\$6,315.00
	RSMB-10G	49853	Green	25	\$7,507.00
	RSMB-10W	49854	White	25	\$7,507.00
	RSMB-10B	49855	Blue	25	\$7,507.00
	RSMB-10Y	49856	Yellow	25	\$7,507.00
	RSMB-10R	49857	Red	25	\$7,507.00

Boîte - (8 x 3/4)

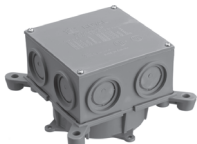
	RSMB-15	49870	Grey	25	\$6,315.00
	RSMB-15G	49871	Green	25	\$6,981.00
	RSMB-15W	49872	White	25	\$7,507.00
	RSMB-15B	49873	Blue	25	\$7,507.00
	RSMB-15Y	49874	Yellow	25	\$7,507.00
	RSMB-15R	49875	Red	25	\$7,507.00

Boîte - (4 x 1/2 - 4 x 3/4)

	RSMB-10-15	49860	Grey	25	\$6,315.00
	RSMB-10-15G	49861	Green	25	\$7,507.00
	RSMB-10-15W	49862	White	25	\$7,507.00
	RSMB-10-15B	49863	Blue	25	\$7,507.00
	RSMB-10-15Y	49864	Yellow	25	\$7,507.00
	RSMB-10-15R	49865	Red	25	\$7,507.00

Boîte - (4 x 1/2 - 2 x 3/4 - 2 x 1)

	RSMB-10-15-20	49891	Grey	25	\$6,315.00
	RSMB-10-15-20G	49892	Green	25	\$7,507.00
	RSMB-10-15-20W	49893	White	25	\$7,507.00
	RSMB-10-15-20B	49894	Blue	25	\$7,507.00
	RSMB-10-15-20Y	49895	Yellow	25	\$7,507.00
	RSMB-10-15-20R	49896	Red	25	\$7,507.00

Boîte - (4 x 3/4 - 2 x 1/2 - 2 x 1)

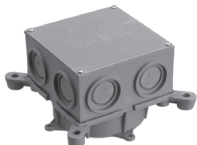
	RSMB-15-20-10	49990	Grey	25	\$6,315.00
	RSMB-15-20-10G	49991	Green	25	\$7,507.00
	RSMB-15-20-10W	49992	White	25	\$7,507.00
	RSMB-15-20-10B	49993	Blue	25	\$7,507.00
	RSMB-15-20-10Y	49994	Yellow	25	\$7,507.00
	RSMB-15-20-10R	49995	Red	25	\$7,507.00

Coupe-tube

Dim

Prix unitaire

	RFCUT	49560	1/2 - 1 1/4	25	\$450.00
	RFCUTBLADE	49570	Blades	1	\$196.00

Boîte logique royal légende de couleurs

	Gris :	Generique	Bleu :	Hydro - 120 Volt
	Vert :	Sécurité, Câble, Téléphone	Jaune :	Lumière d'Urgence et Enseignes Sortie
	Blanc :	Hydro - 600 Volt	Rouge :	Alarm de Feu

