

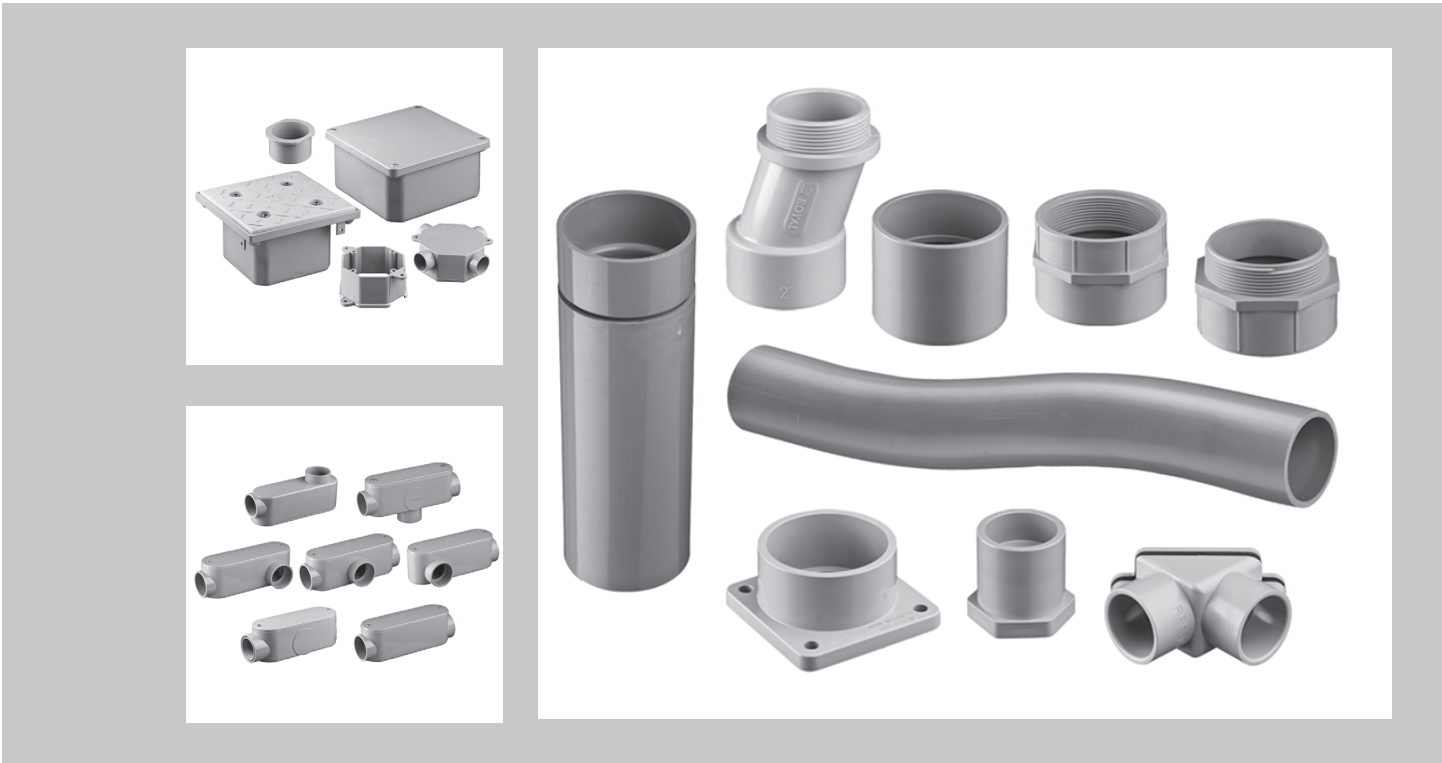

Rigid PVC Conduit Fittings





Canadian National Price List
List No: E-62-03 RCF-PLV21
Effective: February 9, 2024
Replaces: July 4, 2022
All Prices are Taxes Extra







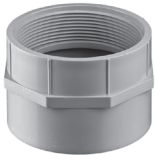

 C22.2 No. 85 Fittings

 UL 50, 514B, 514C, 514D, 651

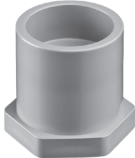
Rigid PVC Conduit Fittings

Description (Fittings)	Product Code	UPC Code	Size (in.)	Carton Quantity	Price Per 100
Coupling					
	REC10	45950	1/2	150	\$410.00
	REC15	45960	3/4	100	\$536.00
	REC20	45970	1	50	\$727.00
	REC25	45980	1 1/4	50	\$945.00
	REC30	45990	1 1/2	25	\$1,286.00
	REC35	46000	2	40	\$1,784.00
	REC40	46010	2 1/2	20	\$3,648.00
	REC45	46020	3	30	\$4,686.00
	REC50	46030	3 1/2	20	\$6,152.00
	REC55	46060	4	20	\$6,577.00
	REC60	46080	5	10	\$17,922.00
	REC65	46090	6	5	\$20,568.00
	REC70	77887	8	2	\$37,228.00
Terminal Adapter					
	RTA10	45730	1/2	200	\$472.00
	RTA15	45740	3/4	150	\$808.00
	RTA20	45750	1	100	\$887.00
	RTA25	45760	1 1/4	50	\$945.00
	RTA30	45770	1 1/2	30	\$1,708.00
	RTA35	45780	2	50	\$1,652.00
	RTA40	45790	2 1/2	25	\$4,440.00
	RTA45	45800	3	50	\$5,282.00
	RTA50	45810	3 1/2	30	\$10,271.00
	RTA55	45820	4	30	\$10,006.00
	RTA60	45830	5	12	\$22,044.00
	RTA65	45840	6	10	\$25,267.00
	Female Adapter				
	RFA10	44990	1/2	150	\$559.00
	RFA15	45000	3/4	100	\$905.00
	RFA20	45010	1	50	\$1,162.00
	RFA25	45020	1 1/4	30	\$1,367.00
	RFA30	45030	1 1/2	25	\$1,776.00
	RFA35	45040	2	30	\$2,503.00
	RFA40	45050	2 1/2	20	\$4,440.00
	RFA45	45060	3	25	\$6,376.00
	RFA50	45070	3 1/2	20	\$10,271.00
	RFA55	45080	4	15	\$10,006.00
	RFA60	45090	5	10	\$22,044.00
	RFA65	45100	6	6	\$25,267.00
	O'ring Expansion Joint				
	REJ10	44870	1/2	25	\$6,698.00
	REJ15	44880	3/4	25	\$6,698.00
	REJ20	44890	1	40	\$7,264.00
	REJ25	44900	1 1/4	20	\$8,765.00
	REJ30	44910	1 1/2	20	\$9,299.00
	REJ35	44920	2	10	\$12,014.00
	REJ40	44930	2 1/2	9	\$23,553.00
	REJ45	44940	3	9	\$17,805.00
	REJ50	44950	3 1/2	5	\$67,306.00
	REJ55	44960	4	5	\$79,573.00
	REJ60	44963	5	1	\$129,587.00
	REJ65	44966	6	1	\$166,294.00

Rigid PVC Conduit Fittings

Description (Fittings)	Product Code	UPC Code	Size (in.)	Carton Quantity	Price Per 100
Reducer Bushings					
	R1805	44500	3/4 x 1/2	3 x 100	\$471.00
	R1805-1	44501	1 x 1/2	3 x 100	\$932.00
	R1806	44502	1 x 3/4	2 x 100	\$670.00
	R1807-1	44505	1 1/4 x 3/4	2 x 25	\$979.00
	R1807	44504	1 1/4 x 1	2 x 50	\$1,194.00
	R1808-1	44507	1 1/2 x 1	50	\$1,286.00
	R1808	44506	1 1/2 x 1 1/4	50	\$1,335.00
	R1809-1	44511	2 x 1	50	\$2,243.00
	R1809	44510	2 x 1 1/4	25	\$2,503.00
	R1810	44512	2 x 1 1/2	25	\$3,053.00
	R1811	44516	2 1/2 x 2	15	\$5,331.00
	R1812-1	44530	3 x 2	25	\$6,086.00
	R1812	44520	3 x 2 1/2	15	\$7,602.00
	R1813-1	44542	4 x 2	15	\$12,293.00
R1813	44540	4 x 3	10	\$13,717.00	
R1814	44547	4 x 3 1/2	15	\$13,983.00	
Threaded Reducer Bushings (Socket and Thread)					
	R1825	44550	3/4 x 1/2	200	\$2,834.00
	R1826	44560	1 x 1/2	200	\$2,948.00
	R1827	44570	1 x 3/4	200	\$2,928.00
5° Coupling (H x H) - Fabricated					
	R5EC35	46800	2	15	\$3,229.00
	R5EC40	46805	2 1/2	12	\$5,576.00
	R5EC45	46810	3	10	\$7,272.00
	R5EC50	46815	3 1/2	15	\$13,819.00
	R5EC55	46820	4	15	\$13,852.00
	R5EC60	46825	5	4	\$22,127.00
	R5EC65	46830	6	6	\$22,127.00
	5° Coupling (H x H) - Moulded	R5ECM45	46812	3	25
R5ECM55		46822	4	25	\$25,208.00
Pull Elbow					
	RPE10	45535	1/2	50	\$2,060.00
	RPE15	45538	3/4	50	\$2,060.00
Long Meter Offset					
	RLMO25	45472	1 1/4	25	\$7,479.00
	RLMO30	45474	1 1/2	25	\$7,530.00
	RLMO35	45476	2	25	\$8,442.00
Meter Offset					
	RMO25	45500	1 1/4	40	\$2,451.00
	RMO35	45510	2	25	\$2,827.00

Rigid PVC Conduit Fittings

Description (Fittings)	Product Code	UPC Code	Size (in.)	Carton Quantity	Price Per 100
------------------------	--------------	----------	------------	-----------------	---------------

90° Elbow - Bell End



REE1090	46120	1/2	35	\$1,236.00
REE1590	46150	3/4	50	\$1,422.00
REE2090	46180	1	25	\$2,184.00
REE2590	46210	1 1/4	20	\$3,070.00
REE3090	46240	1 1/2	15	\$4,346.00
REE3590	46270	2	10	\$6,449.00
REE4090	46330	2 1/2	200	\$14,110.00
REE4590	46360	3	100	\$23,160.00
REE5090	46390	3 1/2	50	\$31,720.00
REE5590	46420	4	50	\$37,708.00
REE6090	46440	5	25	\$139,859.00
REE6590	46460	6	25	\$225,799.00
REE7090	96519	8	25	\$466,727.00

45° Elbow - Bell End

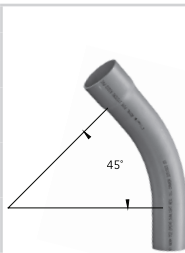

REE1045	46110	1/2	70	\$1,330.00
REE1545	46140	3/4	50	\$1,520.00
REE2045	46170	1	50	\$2,364.00
REE2545	46200	1 1/4	30	\$3,328.00
REE3045	46230	1 1/2	15	\$4,449.00
REE3545	46280	2	10	\$6,972.00
REE4045	46320	2 1/2	10	\$14,110.00
REE4545	46350	3	1	\$23,776.00
REE5045	46380	3 1/2	1	\$31,722.00
REE5545	46410	4	1	\$38,709.00
REE6045	46430	5	1	\$139,859.00
REE6545	46450	6	1	\$225,799.00
REE7045	96520	8	1	\$466,727.00

30° Elbow - Plain End

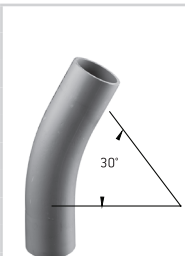

REE1030PE	46100	1/2	50	\$1,330.00
REE1530PE	46130	3/4	35	\$1,520.00
REE2030PE	46160	1	50	\$2,364.00
REE2530PE	46190	1 1/4	30	\$3,328.00
REE3030PE	46220	1 1/2	50	\$4,449.00
REE3530PE	46274	2	30	\$6,972.00
REE4030PE	46310	2 1/2	10	\$14,110.00
REE4530PE	46340	3	10	\$23,776.00
REE5030PE	46375	3 1/2	1	\$31,722.00
REE5530PE	46400	4	1	\$38,709.00
REE6030PE	46425	5	1	\$139,859.00
REE6530PE	46442	6	1	\$225,799.00
REE7030PE	96521	8	1	\$466,727.00







Utilities 90° - Elbow Bell End

Size Radius

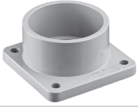





REE2-24	46501	2 24	30	\$48,056.00
REE2-36	46502	2 36	30	\$48,453.00
REE3-24	46503	3 24	25	\$38,152.00
REE3-36	46504	3 36	25	\$60,862.00
REE4-36	46465	4 36	25	\$83,987.00
REE4-48	46505	4 48	25	\$96,222.00
REE5-36	46506	5 36	25	\$139,859.00
REE6-36	46507	6 36	25	\$225,798.00

Rigid PVC Conduit Fittings

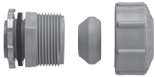
Description (Fittings)	Product Code	UPC Code	Size (in.)	Carton Quantity	Price Per 100
90° Elbow - Extended Plain End					
	REE2590E	46215	1¼	1	\$8,872.00
	REE3090E	46260	1½	1	\$8,872.00
	REE3590E	46290	2	1	\$13,458.00
Meter Hub					
	RMHU25	45480	1¼	50	\$2,562.00
	RMHU30	45485	1½	25	\$2,562.00
	RMHU35	45490	2	50	\$2,562.00
Service Entrance Fitting					
	REF10	44795	½	25	\$2,779.00
	REF15	44800	¾	25	\$2,635.00
	REF20	44810	1	15	\$3,357.00
	REF25	44820	1¼	20	\$5,160.00
	REF30	44830	1½	20	\$8,731.00
	REF35	44840	2	20	\$8,057.00
	REF40	44842	2½	2	\$51,656.00
	REF45	44844	3	2	\$50,320.00
	REF50	44852	3½	2	\$73,492.00
	REF55	44860	4	2	\$115,489.00
	Solvent Weld End Cap				
	RCAP10	44690	½	200	\$484.00
	RCAP15	44700	¾	150	\$593.00
	RCAP20	44710	1	100	\$810.00
	RCAP25	44720	1¼	40	\$1,212.00
	RCAP30	44730	1½	40	\$1,238.00
	RCAP35	44740	2	20	\$1,526.00
	RCAP40	44750	2½	15	\$3,342.00
	RCAP45	44760	3	10	\$4,527.00
	RCAP55	44770	4	12	\$9,973.00
	RCAP60	44780	5	4	\$17,079.00
	RCAP65	44782	6	10	\$23,712.00
Octagonal Box - with Integral Knockouts (*KO Plug)					
	ROB15-10	45520	4 x 1½ (¾ x ½)	20	\$5,060.00
	ROB20	45525	4 x 2 (1)	12	\$8,765.00
	RKO15*	45450	¾	1	\$318.00
	RKO20*	45455	1	1	\$339.00
Octagonal Box Extension Ring					
	RXR20	46490	1	20	\$3,357.00
	RXR35	46495	2	20	\$3,695.00
Strain Relief Connector - with 6 Grommets					
	RSRC15	45685	¾	50	\$2,742.00

Rigid PVC Conduit Fittings

Description (Fittings)	Product Code	UPC Code	Size (in.)	Carton Quantity	Price Per 100
Strain Relief Connector - with 6 Grommets, Lock Nuts and O-Rings					
	RTSRC10	45850	1/2	50	\$2,957.00
	RTSRC15	45855	3/4	50	\$3,823.00
Type 'C' Access Fitting					
	RSC10S	46600	1/2	30	\$4,547.00
	RSC20S	46605	3/4	20	\$2,948.00
	RSC30S	46610	1	15	\$3,500.00
	RSC40S	46615	1 1/4	15	\$6,297.00
	RSC50S	46620	1 1/2	10	\$9,776.00
	RSC60S	45605	2	15	\$12,411.00
	RSC70S	45606	2 1/2	4	\$38,791.00
	RSC80S	45607	3	4	\$38,791.00
	RSC90S	45608	3 1/2	4	\$67,214.00
RSC100S	45609	4	4	\$67,214.00	
Type 'LB' Access Fitting					
	RSLB10S	45620	1/2	25	\$2,308.00
	RSLB20S	45630	3/4	25	\$2,656.00
	RSLB30S	45640	1	15	\$3,456.00
	RSLB40S	45650	1 1/4	20	\$5,708.00
	RSLB50S	45660	1 1/2	10	\$7,499.00
	RSLB60S	45670	2	15	\$11,939.00
	RSLB70S	45675	2 1/2	5	\$38,672.00
	RSLB80S	45680	3	5	\$38,672.00
	RSLB90S	45681	3 1/2	5	\$67,214.00
	RSLB100S	45610	4	5	\$67,214.00
Type 'LL' Access Fitting					
	RSLL10S	46650	1/2	25	\$2,544.00
	RSLL20S	46655	3/4	20	\$2,763.00
	RSLL30S	46660	1	15	\$4,637.00
	RSLL40S	46665	1 1/4	10	\$6,297.00
	RSLL50S	46670	1 1/2	10	\$9,030.00
	RSLL60S	45682	2	10	\$15,071.00
	RSLL70S	46672	2 1/2	4	\$38,791.00
	RSLL80S	46674	3	4	\$38,791.00
	RSLL90S	46676	3 1/2	5	\$67,214.00
	RSLL100S	46678	4	5	\$67,214.00
Type 'LR' Access Fitting					
	RSLR10S	46700	1/2	25	\$2,544.00
	RSLR20S	46705	3/4	20	\$2,763.00
	RSLR30S	46710	1	15	\$4,637.00
	RSLR40S	46715	1 1/4	10	\$6,297.00
	RSLR50S	46720	1 1/2	10	\$9,030.00
	RSLR60S	45683	2	10	\$15,071.00
	RSLR70S	46725	2 1/2	4	\$38,791.00
	RSLR80S	46728	3	4	\$38,791.00
	RSLR90S	46735	3 1/2	5	\$67,214.00
	RSLR100S	46738	4	5	\$67,214.00

Rigid PVC Conduit Fittings

Description (Fittings)	Product Code	UPC Code	Size (in.)	Carton Quantity	Price Per 100
------------------------	--------------	----------	------------	-----------------	---------------

Type 'E' Access Fitting

	RSE10S	46630	1/2	30	\$2,398.00
	RSE20S	46632	3/4	20	\$2,827.00
	RSE30S	46634	1	15	\$3,590.00
	RSE40S	46636	1 1/4	20	\$5,910.00
	RSE50S	46638	1 1/2	10	\$7,499.00
	RSE60S	46640	2	15	\$12,411.00
	RSE70S	46642	2 1/2	4	\$38,777.00
	RSE80S	46644	3	4	\$38,777.00
	RSE90S	46646	3 1/2	4	\$67,215.00
	RSE100S	46648	4	4	\$67,215.00

Type 'T' Access Fitting

	RST10S	45690	1/2	30	\$4,266.00
	RST20S	45700	3/4	20	\$2,855.00
	RST30S	45710	1	25	\$4,082.00
	RST40S	45720	1 1/4	15	\$6,294.00
	RST50S	45723	1 1/2	10	\$8,446.00
	RST60S	45725	2	10	\$15,087.00
	RST70S	46745	2 1/2	4	\$38,791.00
	RST80S	46748	3	4	\$38,791.00
	RST90S	46750	3 1/2	4	\$67,214.00
	RST100S	46752	4	4	\$67,214.00

Type 'TB' Access Fitting

	RSTB10S	45692	1/2	30	\$10,849.00
	RSTB20S	45702	3/4	20	\$11,284.00
	RSTB30S	45712	1	10	\$12,643.00
	RSTB40S	45721	1 1/4	10	\$14,883.00
	RSTB50S	45724	1 1/2	15	\$18,042.00
	RSTB60S	45727	2	10	\$20,288.00
	RSTB70S	46760	2 1/2	4	\$53,974.00
	RSTB80S	46762	3	4	\$53,974.00
	RSTB90S	46764	3 1/2	4	\$75,235.00
	RSTB100S	46766	4	4	\$75,235.00



PVC Pipe Strap - 2 Hole

	RPS10	45540	1/2	4 x 100	\$182.00
	RPS15	45550	3/4	4 x 100	\$229.00
	RPS20	45560	1	5 x 100	\$262.00
	RPS25	45570	1 1/4	8 x 50	\$339.00
	RPS30	45580	1 1/2	9 x 25	\$385.00
	RPS35	45590	2	8 x 25	\$510.00

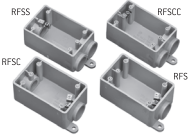
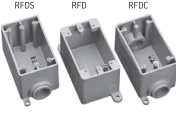
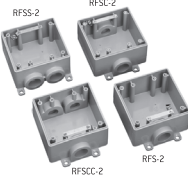

Steel Pipe Strap - 2 Hole PVC Coated

	RCS35	44783	2	50	\$1,829.00
	RCS40	44784	2 1/2	50	\$1,869.00
	RCS45	44785	3	25	\$2,152.00
	RCS50	44786	3 1/2	25	\$2,826.00
	RCS55	44787	4	15	\$5,017.00
	RCS60	44788	5	10	\$5,070.00
	RCS65	44789	6	5	\$11,480.00

Rigid PVC Conduit Fittings

Description (Fittings)	Product Code	UPC Code	Size (in.)	Carton Quantity	Price Per 100
Steel Pipe Strap - 1 Hole PVC Coated					
	RCS10-1	46850	1/2	250	\$1,112.00
	RCS15-1	46852	3/4	250	\$1,165.00
	RCS20-1	46854	1	100	\$1,331.00
	RCS25-1	46856	1 1/4	50	\$1,682.00
	RCS30-1	46858	1 1/2	50	\$2,022.00
	RCS35-1	46860	2	45	\$2,673.00
	RCS40-1	46862	2 1/2	25	\$4,973.00
	RCS45-1	46864	3	20	\$4,973.00
	RCS55-1	46866	4	4	\$5,507.00
Single Gang Boxes - F Series					
	RFSS10	45200	1/2" FS	10	\$4,668.00
	RFSS15	45210	3/4" FS	10	\$4,424.00
	RFSS10	45240	1/2" FSS	10	\$4,977.00
	RFSS15	45250	3/4" FSS	10	\$4,725.00
	RFSC10	45220	1/2" FSC	10	\$4,977.00
	RFSC15	45230	3/4" FSC	10	\$4,725.00
	RFSCC10	45233	1/2" FSCC	10	\$5,664.00
	RFSCC15	45235	3/4" FSCC	10	\$5,664.00
	Single Gang Deep Boxes - FD Series				
	RFDS10	45178	1/2" FDS	10	\$5,906.00
	RFDS15	45180	3/4" FDS	10	\$5,906.00
	RFDS20	45190	1" FDS	10	\$5,906.00
	RFDC10	45170	1/2" FDC	10	\$6,329.00
	RFDC15	45175	3/4" FDC	10	\$6,329.00
	RFDC20	45177	1" FDC	10	\$6,329.00
	RFD	45160	BLANK	10	\$6,410.00
	RFD347	45162	347 volt	10	\$8,545.00
	Double Gang Boxes - F Series				
	RFSS2-10	45205	1/2" FS	10	\$8,025.00
	RFSS2-15	45215	3/4" FS	10	\$8,025.00
	RFSS2-20	45216	1" FS	10	\$8,025.00
	RFSS2-10	45242	1/2" FSS	10	\$9,282.00
	RFSS2-15	45244	3/4" FSS	10	\$9,282.00
	RFSS2-20	45246	1" FSS	10	\$9,282.00
	RFSC2-10	45222	1/2" FSC	10	\$8,025.00
	RFSC2-15	45231	3/4" FSC	10	\$8,025.00
	RFSC2-20	45226	1" FSC	10	\$8,025.00
	RFSCC2-10	45234	1/2" FSCC	10	\$10,188.00
	RFSCC2-15	45238	3/4" FSCC	10	\$10,188.00
	RFSCC2-20	45239	1" FSCC	10	\$10,188.00
	RFD-2	45150	BLANK	10	\$9,966.00
Triple Gang Boxes - F Series					
	RFSS3-10	45224	1/2" FSC	10	\$8,817.00
	RFSS3-15	45232	3/4" FSC	10	\$8,817.00
	RFSS3-20	45228	1" FSC	10	\$8,817.00
	RFSS3-10	45208	1/2" FS	10	\$8,817.00
	RFSS3-15	45218	3/4" FS	10	\$8,817.00
	RFSS3-20	45219	1" FS	10	\$8,817.00
	RFD-3	45155	BLANK	10	\$11,623.00

Rigid PVC Conduit Fittings

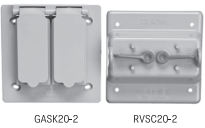
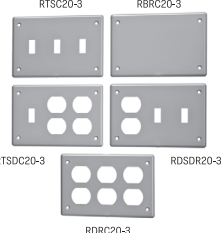
Description (Fittings)	Product Code	UPC Code	Size (in.)	Carton Quantity	Price Per 100
Single Gang Cover Plate - F Series					
	Switch	RTSC15-10	45845	100	\$1,972.00
	Duplex Receptacle	RDRC15-10	44685	100	\$1,972.00
	Single Receptacle 15 Amp	R20RC15-10	47035	100	\$1,972.00
	Single Receptacle 20 Amp	R20-3RC15-10	47036	100	\$1,972.00
	Single Receptacle 30 Amp	R30-3RC15-10	47037	100	\$1,972.00
	Blank W/Gasket	RBRC15-10	44680	100	\$2,008.00
	Single Gasket	GASK15-10	44682	1	\$320.00
Weatherproof Single Gang Cover Plate					
	Toggle	RVSC15-10	45940	20	\$8,162.00
	Plunger	RVPT15-10	45930	20	\$9,451.00
	Switch	RWTG15-10	47339	20	\$3,855.00
	Duplex	RWDR15-10	46093	20	\$3,855.00
	Duplex White	RWDR15-10W	46094	20	\$3,855.00
	Ground Fault	RWGF15-10	46095	20	\$3,855.00
	Ground Fault White	RWGF15-10W	46098	20	\$3,855.00
	15 Amp	RWTL15	46470	20	\$5,748.00
	20 Amp	RWTL20	46472	20	\$5,748.00
	30 Amp	RWTL30	46480	20	\$7,178.00
	50 Amp	RWTL50	46482	20	\$8,971.00
	Single W/P Gasket	GASK W	46484	1	\$1,071.00
Double Gang Cover Plate					
	Double Switch	RTSC20-2	45846	50	\$2,022.00
	Duplex/Switch	RTSDC20-2	45847	50	\$2,022.00
	Double Duplex	RDRC20-2	44686	50	\$2,071.00
	Double Blank W/Gasket	RBRC20-2	44681	50	\$2,826.00
	Double Gasket	GASK20-2	45949	1	\$1,095.00
Weatherproof Double Gang Cover Plate - F Series					
	Double Toggle	RVSC20-2	45941	10	\$12,875.00
	Plunger/GFI	RVSRC20-2	45947	10	\$15,512.00
	Plunger/Duplex	RVSDR20-2	45945	10	\$16,263.00
	Double Door GFI Receptacle	RVSGG20-2	-	15	\$4,914.00
	Double Door Duplex Recept.	RVSDD20-2	-	15	\$4,914.00
	Double W/P Gasket	GASK20-2	45949	1	\$1,095.00
Triple Gang Cover Plate - F Series					
	Triple Switch	RTSC20-3	45857	50	\$3,833.00
	Double Switch/Receptacle	RDSDR20-3	44689	50	\$3,833.00
	Double Receptacle/Switch	RTSDC20-3	45858	50	\$3,833.00
	Triple Receptacle	RDRC20-3	44688	50	\$3,512.00
	Triple Blank W/Gasket	RBRC20-3	44683	50	\$3,512.00
	Triple Gasket	GASK20-3	45859	1	\$1,125.00

Rigid PVC Conduit Fittings

Description (Fittings)	Product Code	UPC Code	Size (in.)	Carton Quantity	Price Per 100
------------------------	--------------	----------	------------	-----------------	---------------

Junction Box - with Gasket (Specialty Box, Any Size - P.O.A. for Zone 1,2, 3 & 4)

	RJB442	45300	4 x 4 x 2	15	\$4,213.00
	RJB444	45310	4 x 4 x 4	10	\$8,418.00
	RJB446	45315	4 x 4 x 6	8	\$13,730.00
	RJB552	45320	5 x 5 x 2	12	\$9,816.00
	RJB664	45330	6 x 6 x 4	15	\$13,664.00
	RJB666	45335	6 x 6 x 6	4	\$22,580.00
	RJB884	45340	8 x 8 x 4	4	\$23,320.00
	RJB887	45350	8 x 8 x 7	4	\$34,922.00
	RJB12124	45280	12 x 12 x 4	2	\$62,270.00
	RJB12126	45290	12 x 12 x 6	4	\$67,689.00
RJB12128	45295	12 x 12 x 8	3	\$111,886.00	

Highway Box - with Fibre Reinforced Security Lid

Price Each

	RH664	47040	6 x 6 x 4	4	\$1,019.00
	RH666	47041	6 x 6 x 6	3	\$1,095.00
	RH884	47042	8 x 8 x 4	3	\$1,697.00
	RH886	47043	8 x 8 x 6	2	P.O.R
	RH887	47044	8 x 8 x 7	2	\$1,744.00
	RH887-A	47045	8 x 8 x 7	2	\$1,784.00

Junction Box Adapters

	RJBA10	45360	1/2	100	\$935.00
	RJBA15	45370	3/4	100	\$1,089.00
	RJBA20	45380	1	100	\$2,507.00
	RJBA25	45390	1 1/4	50	\$2,562.00
	RJBA30	45400	1 1/2	50	\$2,622.00
	RJBA35	45410	2	25	\$2,644.00
	RJBA40	45420	2 1/2	10	\$3,145.00
	RJBA45	45430	3	10	\$3,787.00
	RJBA50	45435	3 1/2	10	\$3,827.00
	RJBA55	45440	4	10	\$3,837.00

Fabricated Bell Ends - Spigot End

	RFEB10	46900	1/2	200	\$4,831.00
	RFEB15	46902	3/4	150	\$4,387.00
	RFEB20	46904	1	50	\$4,387.00
	RFEB25	46906	1 1/4	35	\$4,387.00
	RFEB30	46908	1 1/2	25	\$4,387.00
	RFEB35	46910	2	10	\$7,686.00
	RFEB40	46912	2 1/2	6	\$7,686.00
	RFEB45	46914	3	12	\$12,050.00
	RFEB50	46916	3 1/2	8	\$15,456.00
	RFEB55	46918	4	4	\$16,982.00
	RFEB60	46920	5	6	\$45,067.00
	RFEB65	46922	6	10	\$45,063.00

Rigid PVC Conduit Fittings

Description (Fittings)	Product Code	UPC Code	Size (in.)	Carton Quantity	Price Per 100
------------------------	--------------	----------	------------	-----------------	---------------

Moulded Bell Ends - Spigot End Bell

	REB10	47580	1/2	100	\$4,393.00
	REB15	47581	3/4	100	\$4,393.00
	REB20	46940	1	50	\$4,393.00
	REB25	47582	1 1/4	50	\$4,393.00
	REB30	46942	1 1/2	50	\$4,393.00
	REB35	46944	2	40	\$4,393.00
	REB40	47583	2 1/2	30	\$6,988.00
	REB45	46946	3	50	\$10,953.00
	REB50	46948	3 1/2	50	\$14,038.00
	REB55	46950	4	50	\$15,428.00
	REB60	46952	5	25	\$40,922.00
	REB65	46954	6	15	\$40,922.00

Conduit Clamp

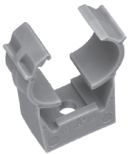
	RCCS10	55042 1	1/2	100	\$593.00
	RCCS15	55044 5	3/4	100	\$720.00
	RCCS20	55046 9	1	100	\$819.00
	RCCS25	55048 3	1 1/4	100	\$883.00
	RCCS30	55050 6	1 1/2	100	\$979.00
	RCCS35	55052 0	2	100	\$1,071.00

Duplex Floor Boxes and Cover (*Polycarbonate Bronze Cover)

	RFDB4	46980	4 x 3/4	-	\$40,193.00
	RFDB2	46982	2 x 3/4	-	\$40,193.00
	RFDBC*	46984	2 x 1	-	\$21,932.00
NOTE: RFDB4 Comes with 4 of 3/4" - 1/2" Bushings RFDB2 Comes with 2 of 3/4" - 1/2" Bushings					

Expansion & Deflection Fitting Assembly

					Price Each
	RSEJ35	46990	2	1	\$1,156.00
	RSEJ45	46992	3	1	\$1,919.00
	RSEJ55	46994	4	1	\$2,308.00

Conduit Shears & Blades

					Price Each
	RCUTTERHD	41855	1/2 - 1" Conduit Shears	1	P.O.R
	RCBLADES	41856	Blades-Conduit Shear Blades	1	P.O.R

All Prices are Per 100 Unless Otherwise Indicated