

1" - 11.5TPI NPT

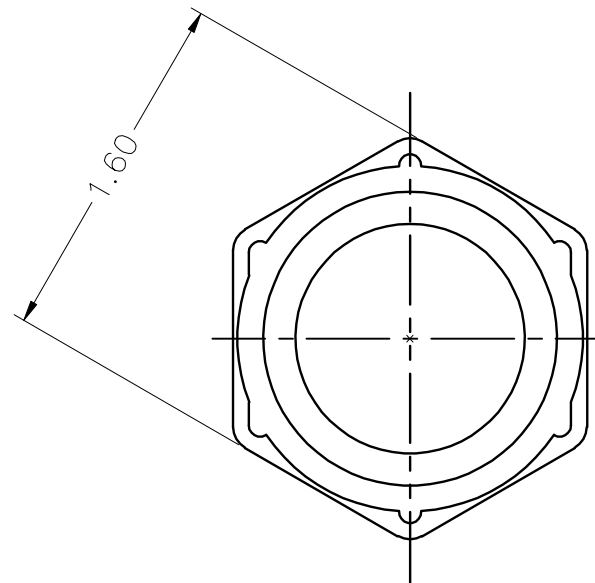

DIMENSIONS SUBJECT TO REVISION W/O NOTICE.

TERMINAL ADAPTER

SIZE 1"

PLASTIC TRENDS
.COM

56400 Mound Road, Shelby Township, MI 48316
 Phone (586) 781-2700 Fax (586) 781-0888

PRINTED COPIES ARE FOR REFERENCE ONLY

DATE 5/16/2007 BY KJS

E011100.D01